

# MASTERS 2016

The Premier Technical Training Conference for Embedded Control Engineers



## MTR

**Счетчики энергоресурсов:  
электроэнергии, газа, воды,  
тепла. Передача данных**

# Счетчик газа

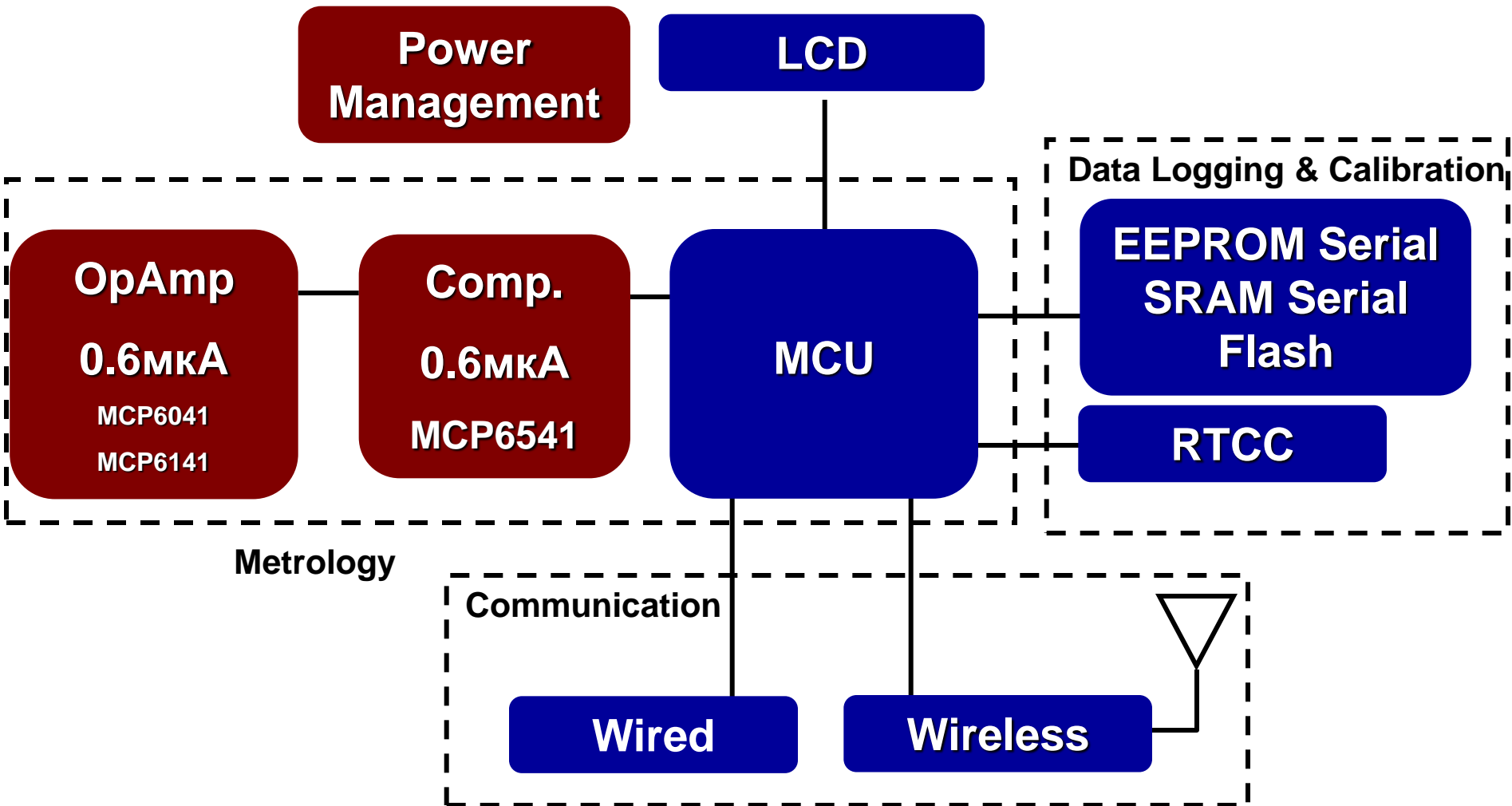

# Счетчик воды

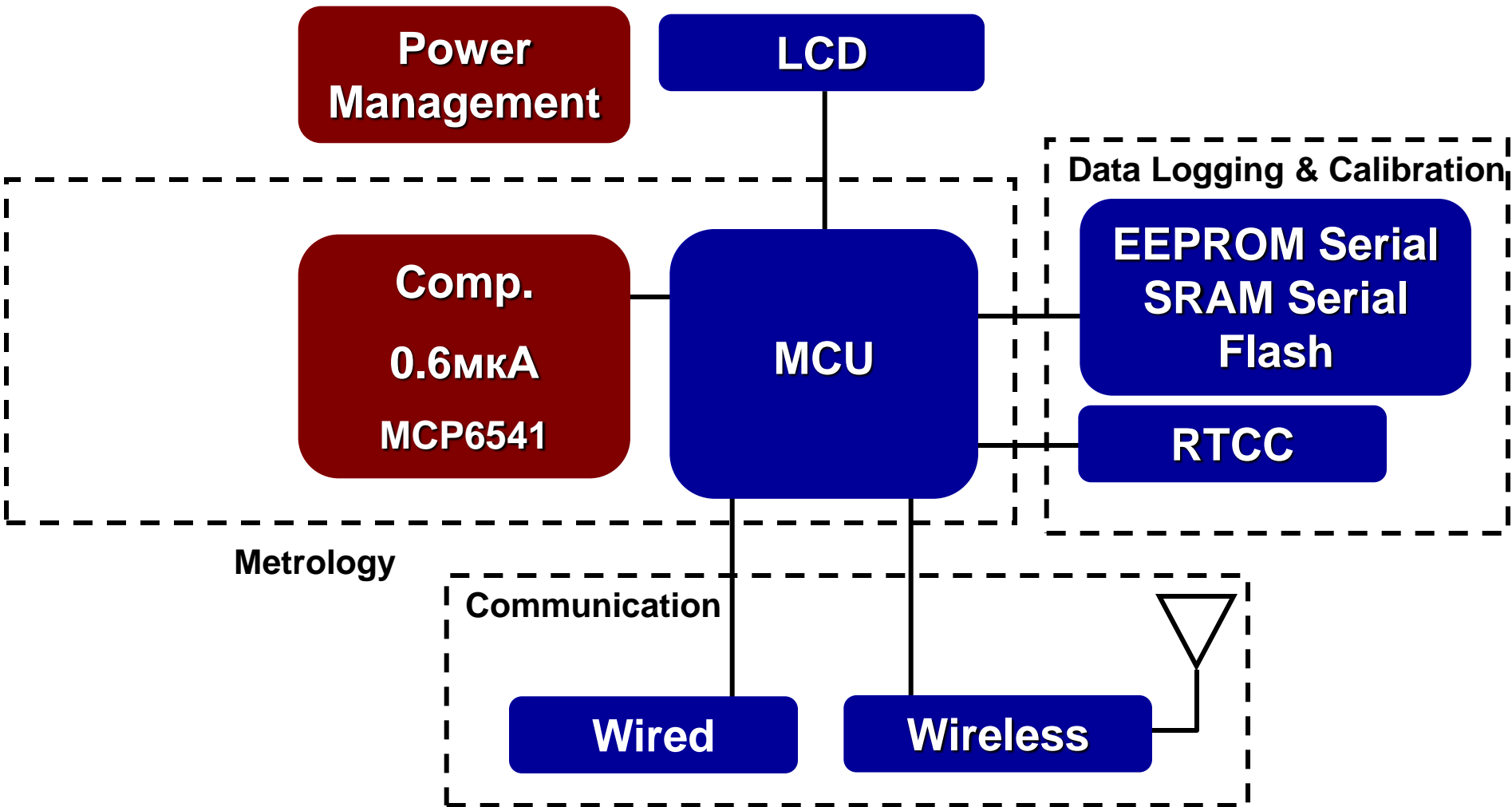

# Микроконтроллеры

- **PIC XLP микроконтроллеры с CIP**
  - Суммарное потребление от 1.5мкА
- **picoPower Atmel**
  - SAM L21, L22 (с драйвером ЖКИ)
    - **CIP, Power Domain Partitioning**
    - **См. класс по XLP**

# Low Iq LDO

Part Number	Iout Max	Vin Range	Iq typ	Dropout Voltage	Key Features	Package
MCP1711	150 mA	1.4 – 6.0V	0.6uA	500 mV	Ultra Low Iq, Capless where applicable	1x1mm DFN SOT-23
MCP1700	200 mA	2.3 – 6.0V	1.6uA	178 mV	Ultra Low Iq, Low Dropout	SOT-23 SOT-89 TO-92 2x2mm DFN6
MCP1703	250 mA	2.7 – 16V	2.0uA	625 mV	Ultra Low Iq, High Input Voltage	SOT-23 SOT-89 TO-92 2x3mm DFN8
MCP1810	150 mA	2.3 – 6.0V	0.02uA	450 mV	Lowest Iq in the Market	2x2mm DFN8
MIC5281/2	25/50 mA	6.0 – 120V	6.0uA	2000 mV	Ultra High Input Voltage, Low Iq	MSOP8
MIC5232	10 mA	2.7 - 7V	1.8uA	100 mV	7V Input, Low Iq	TSOT-5 VDFN6

# MCP1711

## Ultra Low Iq, Capless LDO

### Features:

- Ultra Low Iq of 0.6uA typ
- Very Accurate Output of 20mV Offset for Output of 1.2 to 1.8V
- Vin: 1.4V to 6.0V
- Stable Without Output Capacitor
- Available Package
  - 1x1mm DFN
  - SOT-23

### Applications:

- Energy Harvesting
- Long-Life, Battery-Powered Applications
- Portable Electronics
- Ultra-Low Consumption Products

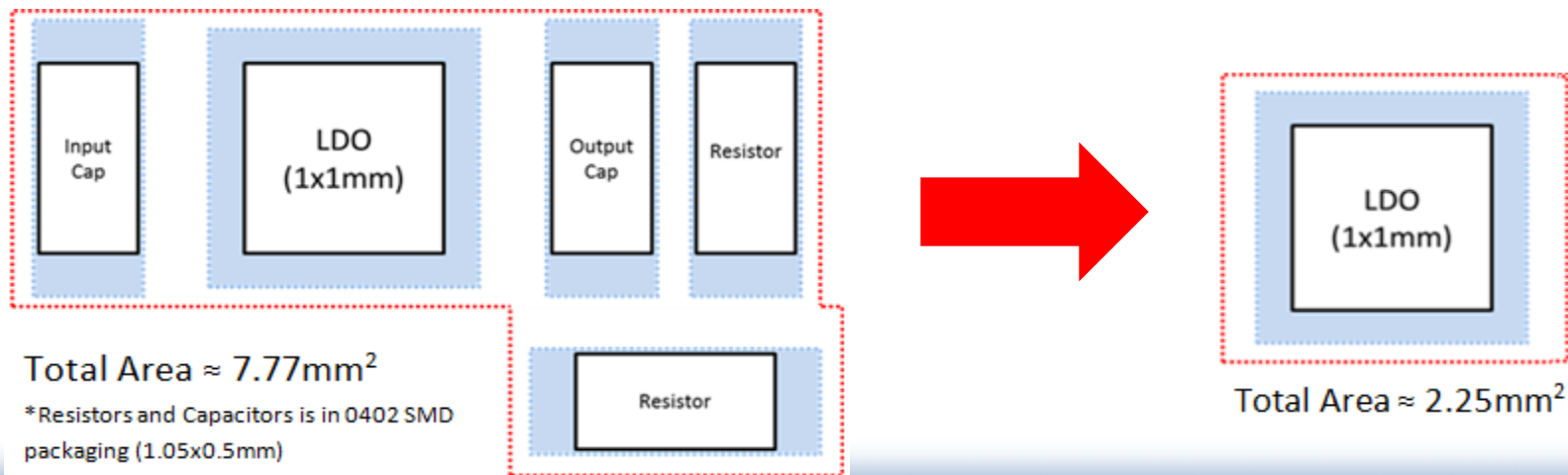

# MCP1810

- **(Super) Ultra Low Iq**  
– увеличивает срок службы от батарей
  - Потребляет лишь 0.02мкА (20нА) (типичное значение)
  - Для приборов с питанием от батарей
  - Потребление меньше в 50 раз чем ближайшие конкуренты

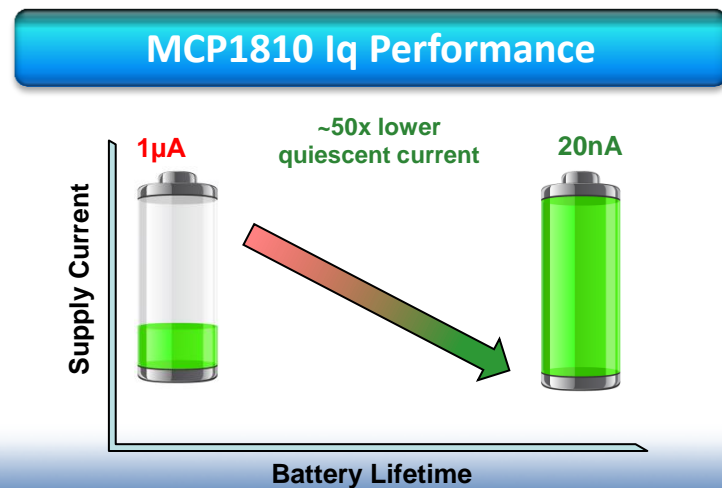



# MASTERS 2016

The Premier Technical Training Conference for Embedded Control Engineers



## Using CVD Measurement for a Flow/Heat Meters



# Using CVD

- **Very low cost solution**
- **Based on ADC measurement only**
- **Very low power consumption**
- **Based on low cost PIC16 MCU**
- **Rotation detection possible**
- **Using mutual capacitance**
- **Ideal for existing meters**
  - Works as additional header

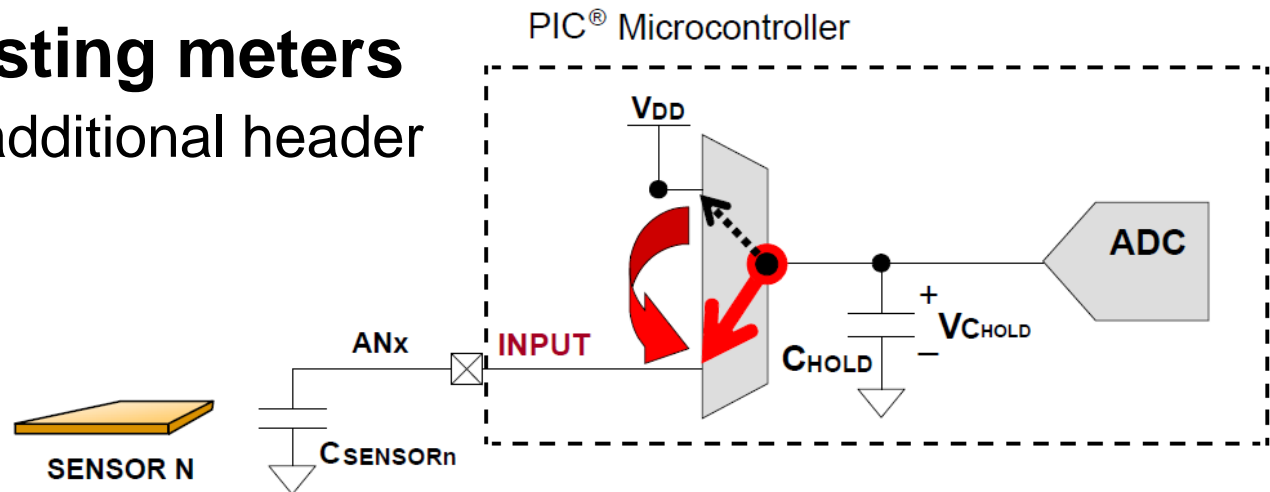

# Applications

- **Flow meters with mechanical transmission**
- **Heat meters**
- **Gas meters**
- **Any meters using rotating element**



# Measurement basics

- **Sensor built using three elements**
- **Each element works as a charge driver or receiver**
- **Modified CVD algorithm to read a charge**
- **When a metal part appears under the sensor the more charge is injected, the capacitance increases**

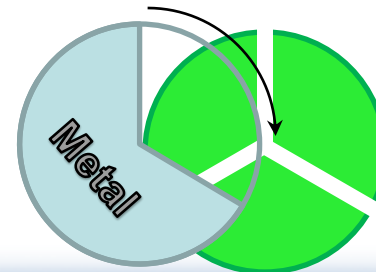

# Measurement basics cont.

- Application follow up the measurement result from three sensors, the rotation direction can be distinguish
- Results are shifted with  $120^\circ$
- Sensitivity depends on distance between the wheel and the sensor



# Measurement basics cont.

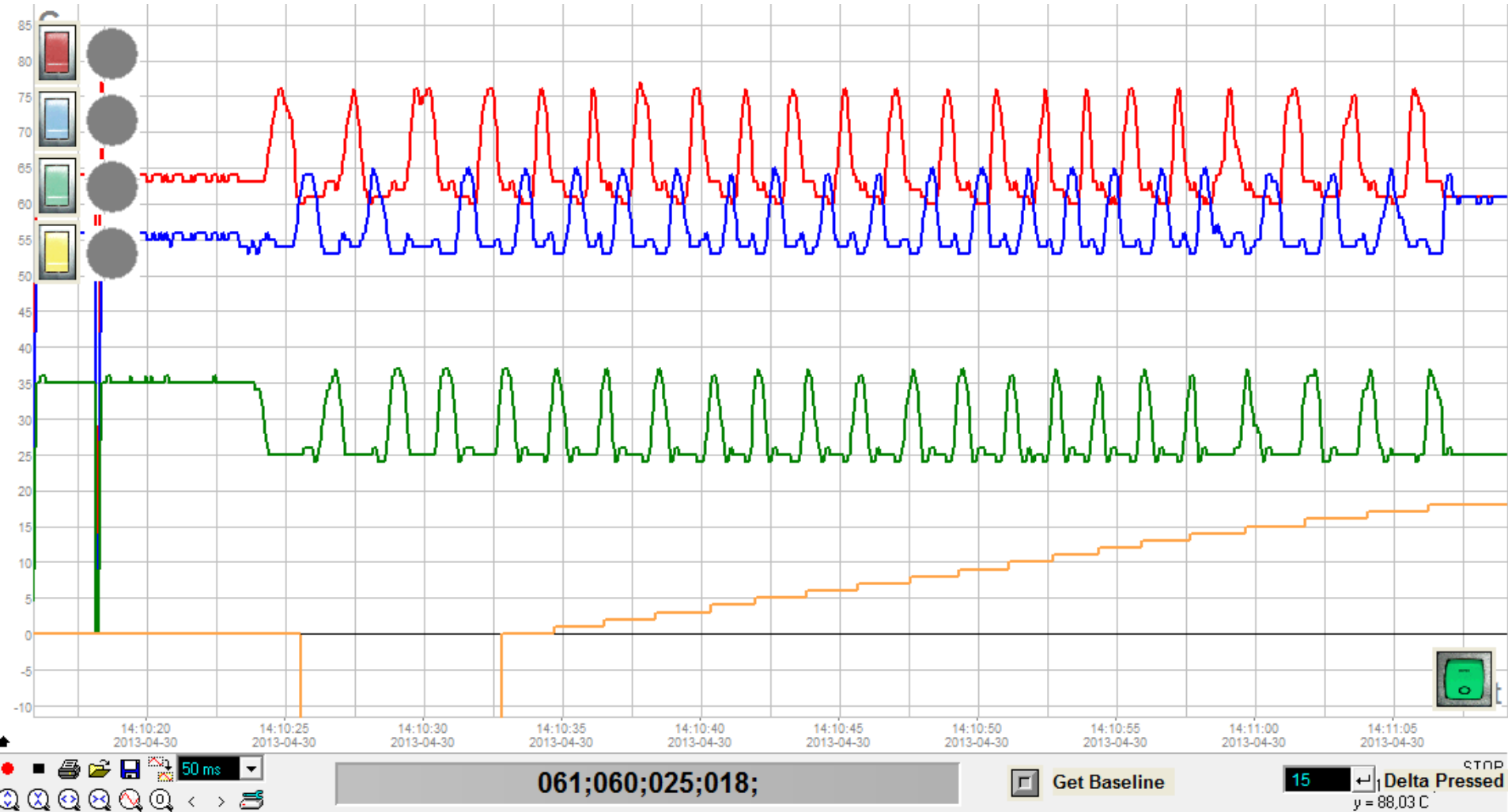

# Example

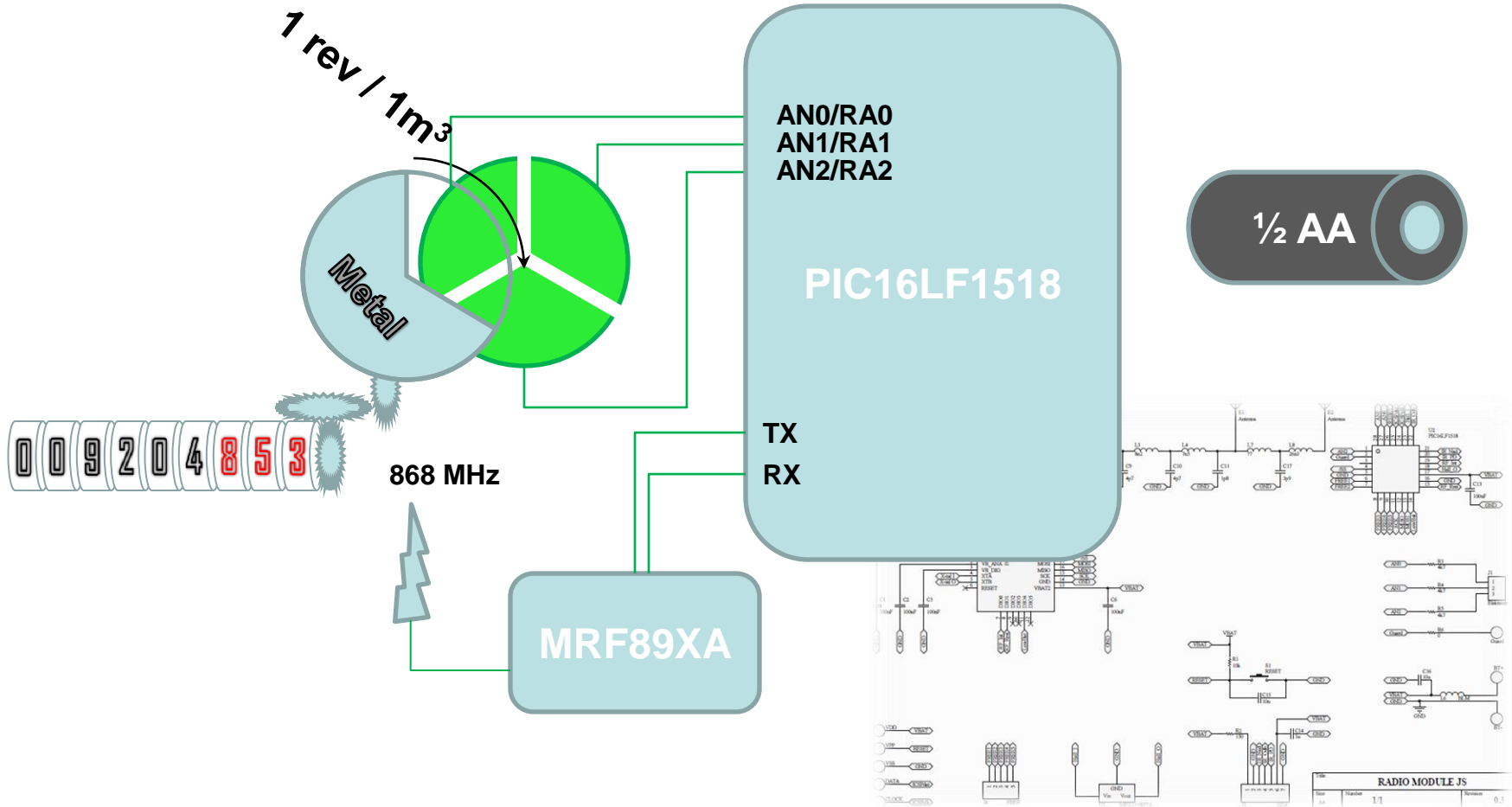

# Features

- Overall power consumption  $< 2 \mu\text{W}$  
- Possible 7 years on half AA battery together with radio transmission
- Reading the revolution of slow rotating wheel (1 rev @ 1m<sup>3</sup>, 1 rev per second)
- Higher speed possible



# Additional features

- **Cap touch sensor for activating display possible to implement**
- **Sealed cover possible – hole for button not needed**
- **Additional high accuracy temperature measurement may be used for heat meters**

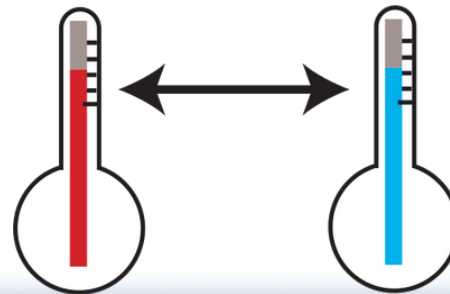
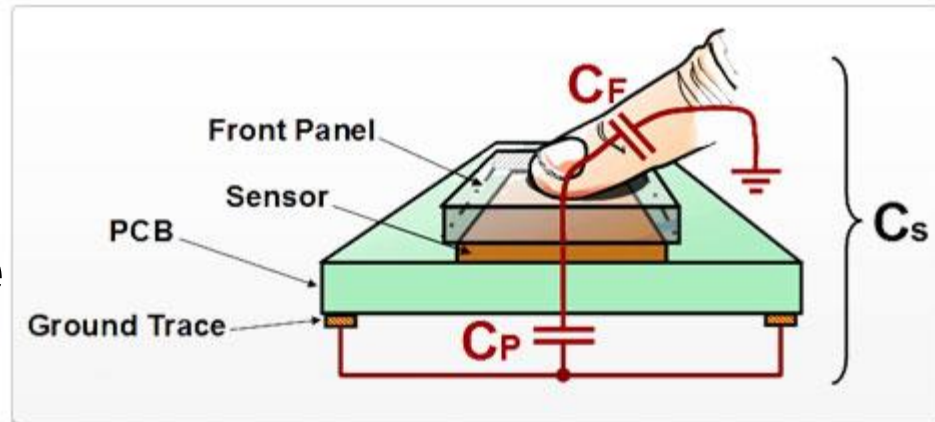

# MASTERS 2016

The Premier Technical Training Conference for Embedded Control Engineers



## Using Inductive Measurement for a Flow/Heat Meters

# Using CTMU

- **High accuracy time difference measurement**
- **Based on impulse slope change measurement**
- **Air coil and magnetic core coils possible**
- **Immune for external magnetic field when using air coil**
- **Rotation detection based on two separate sensors measurement**

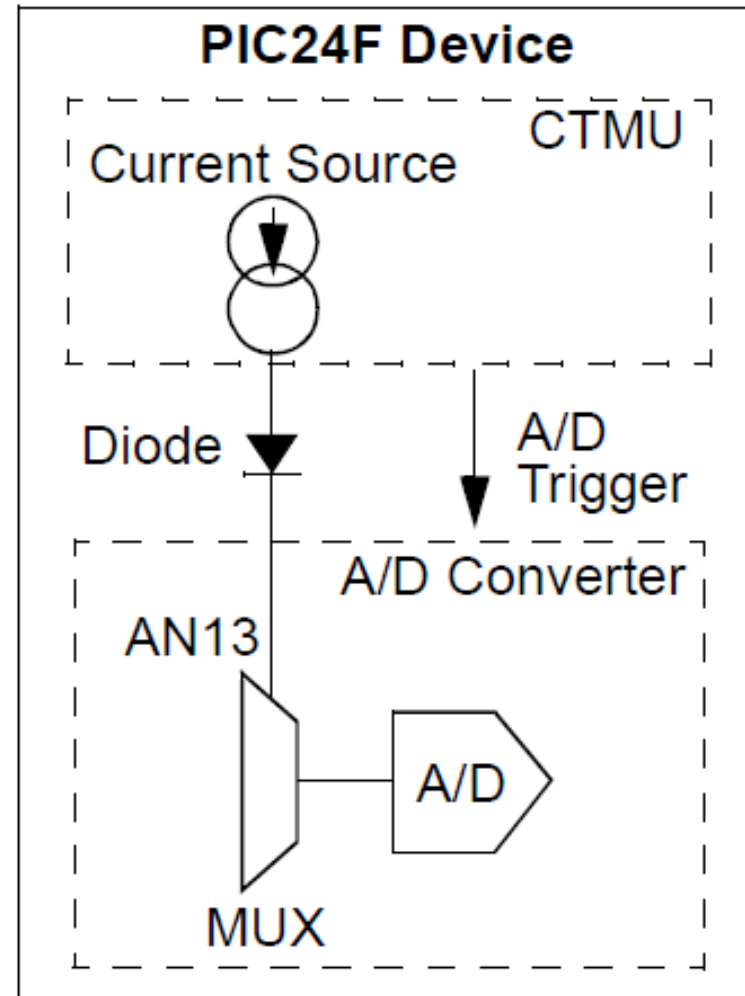

# Applications

- **Flow meters with direct measurement**
- **Flow meters with mechanical transmission**
- **Heat meters (CTMU used as a high accuracy temperature measurement unit)**
- **Gas meters**
- **Any meters using rotating element**



# Measurement basics

- **Internal current source drives internal S&H capacitor**
- **Start triggered by coil impulse**
- **Stop triggered by coil response**
- **Measures the time between start and stop condition**
- **When a metal part appears under coil the time increases**

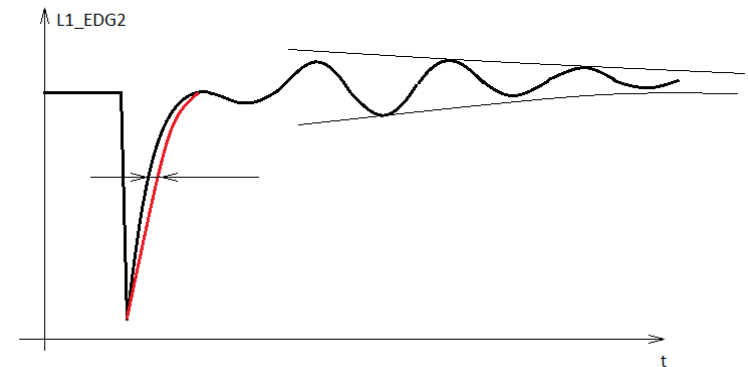

# Measurement basics cont.

- Eddy currents induced in the metal part cause changes in the coil inductance
- Metal elements should have high conductivity (like copper or

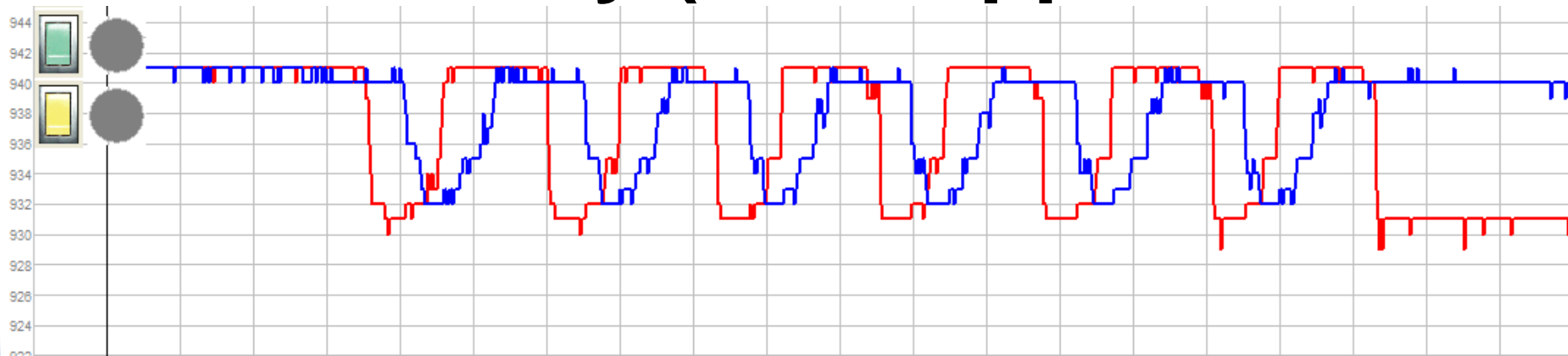

# Sensor shape

- Using printed coil on 4 layer PCB
- Can be matched to the rotating element shape
- Not expensive in mass production
- Immune to the external magnetic field

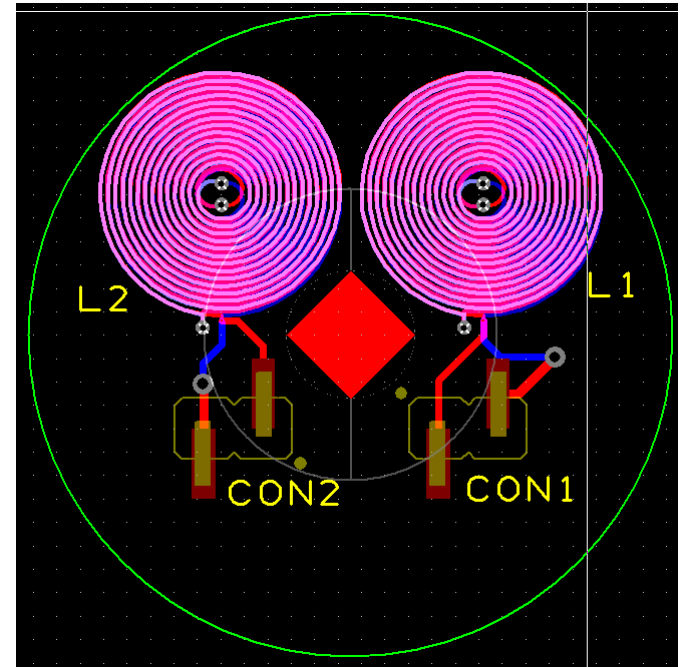



# Sensor shape

- **The best sensitivity when the coil shape match the metal element**
- **The proposal of quater wheel**

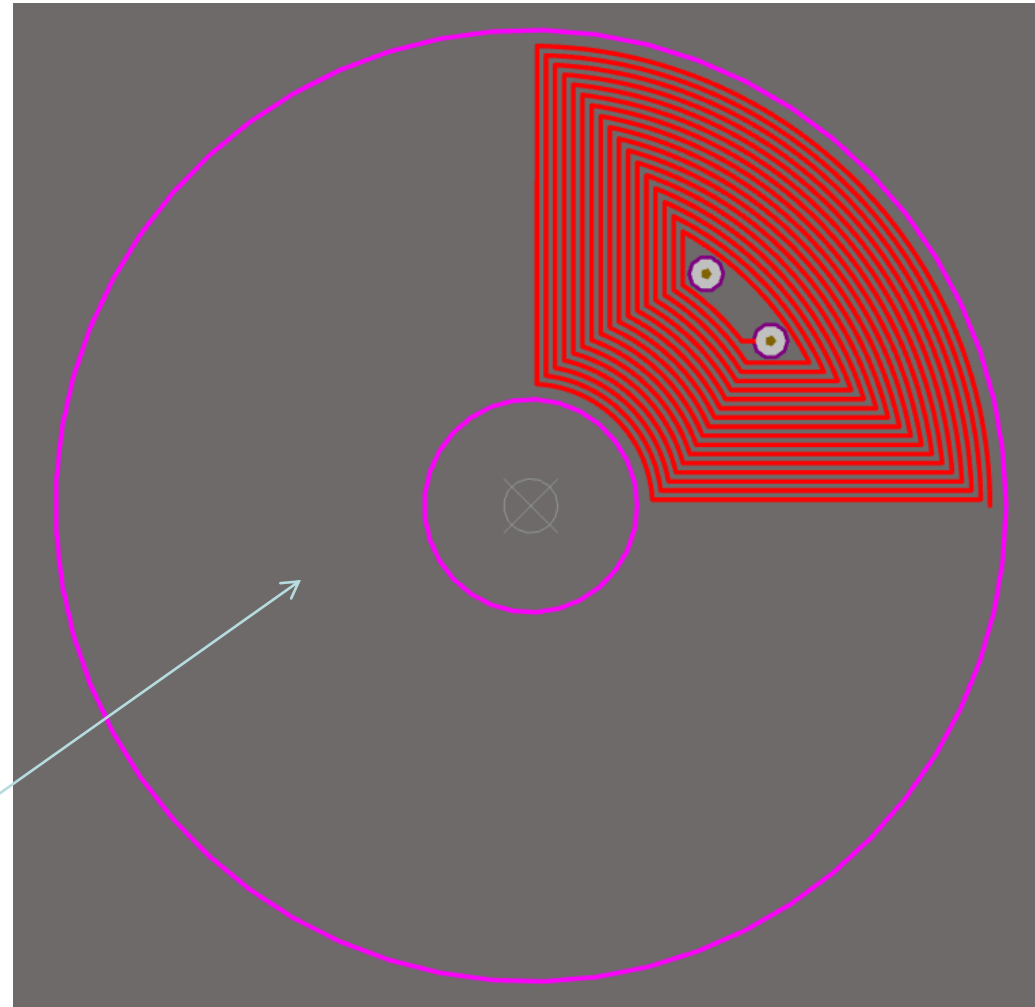

# Extreme Low Power



- **About 0.8  $\mu$ A in sleep mode using external 32.768 kHz crystal and RTCC**
- **Average current depend on sampling Frequency**

Vdd	Scan frequency	PR1 register	Avg. Current 2 sens (Fosc = 32 MHz) [ $\mu$ A]	Avg. Current 2 sens (Fosc = 8 MHz) [ $\mu$ A]	Avg. Current 1 sens (Fosc = 32 MHz) [ $\mu$ A]	Avg. Current 1 sens (Fosc = 8 MHz) [ $\mu$ A]	Max RPS (2 sens)	Max RPS (1 sens)	Max RPM (2 sens)	Max RPM (1 sens)
3.0 V	0 Hz	---	0,84	0,84	0,84	0,84	---	---	---	---
	4 Hz	8192	3	4	2	3	1	2	60	120
	10 Hz	3277	5	9	3	6	2,5	5	150	300
	16 Hz	2048	7	12	6	9	4	8	240	480
	64 Hz	512	30	45	23	34	16	32	960	1920
	128 Hz	256	58	88	45	66	32	64	1920	3840
	256 Hz	128	115	174	88	129	64	128	3840	7680
	512 Hz	64	225	340	173	255	128	256	7680	15360

# PIC24F platform



- Extreme low power
- CTMU on board
- 16-bit / 16 MIPS core for fast operation
- LCD driver for direct drive on board (PIC24FJxxxGA3xx series)

- RTCC (Real Time and Calendar) on board

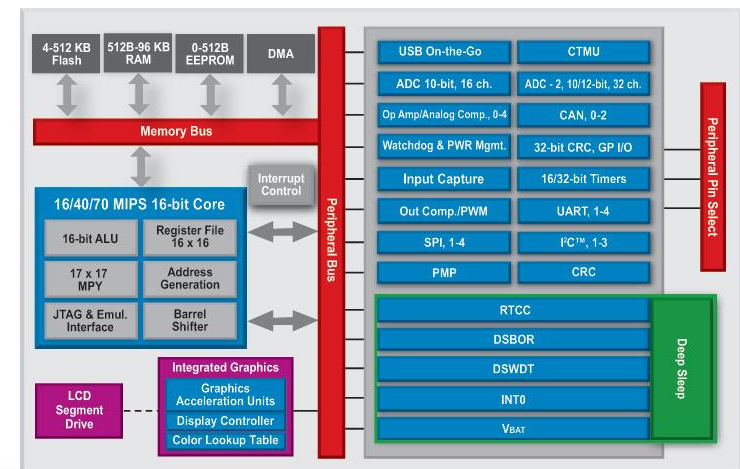

# Additional features

- Cap touch sensor for activating display possible to implement
- Sealed cover possible – hole for button not needed

- Additional high accuracy temperature measurement may be used for heat meters

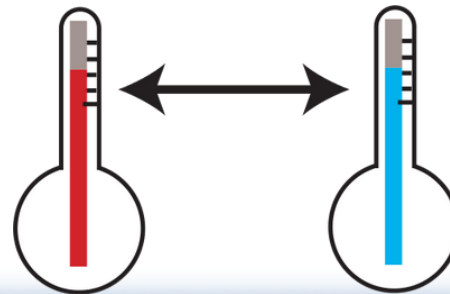
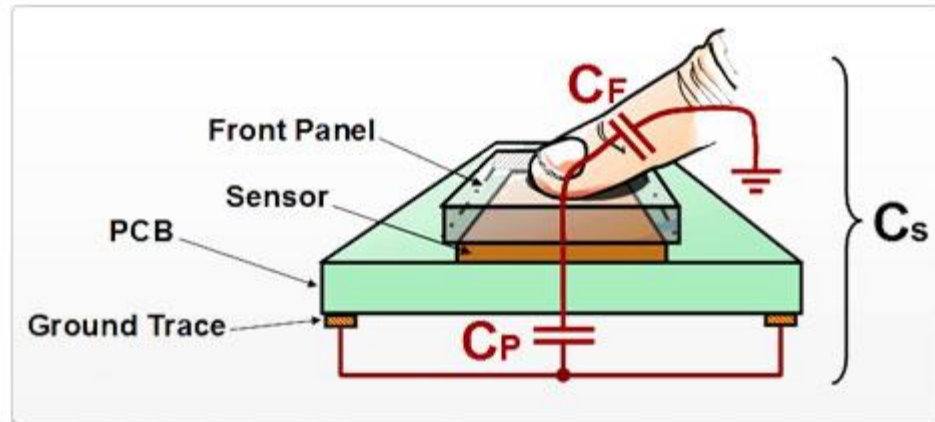

# Счетчик электроэнергии

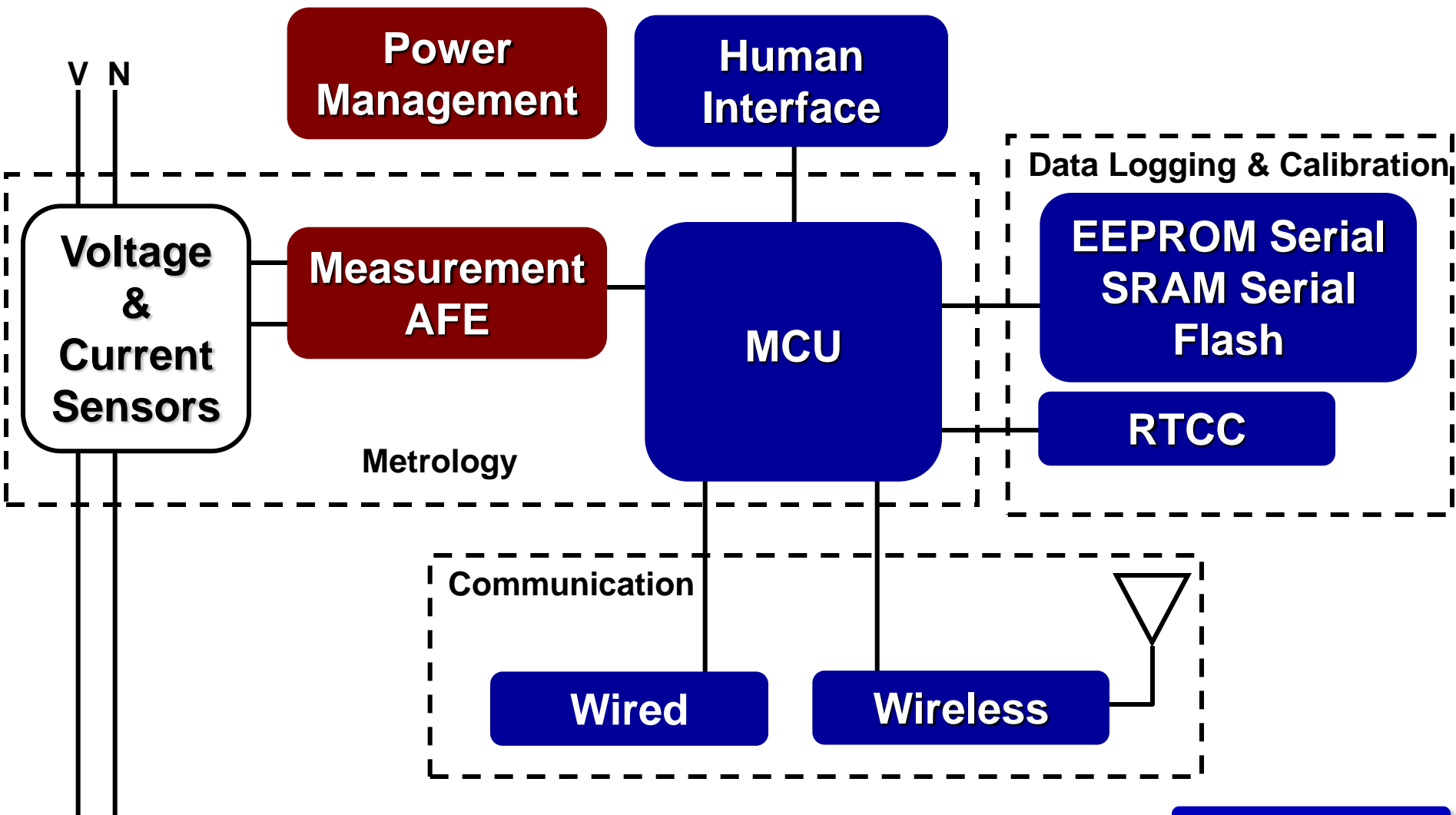

<< BACK to CONTENTS

# Microchip/Atmel AFE

Part Number	MCP3910/12/13/14/18	ATSENSE101/201/301
# of ADCs	1/2/4/6/8	3/4/7
Dynamic Range	0.1%, 10,000:1	0.1%, 3,000:1
SINAD	93.5-94.5 dB	84 dB
Voltage Reference	9 ppm/°C	10 (H-Ver) or 50 ppm/°C
PGA	Up to 32x, All Channels	Up to 8x, Current Channels
Digital Temp. Compensation of Vref	No	Yes
Phase Delay Comp.	Yes	No
CRC	Yes, 16-bit	No
2-Wire Mode	Yes (Poly-Phase Shunt)	No
Temperature Range	- 40°C, +125°C	- 40°C, +85°C
Package	SSOP20, QFN20	SOIC20, TQFP32
Metrology FW	Limited	Available (supporting IEC & ANSI Stds)
Implementation Cost	\$	\$

# AFE Summary

- **MCP391x – для промышленных решений и электросчетчиков**
  - Larger Temp Range covering Up to +125°C
  - 2 Wire Mode I/F support to reduce BOM on 3P shunt based meters
  
- **ATsense – для электросчетчиков**
  - Tightly coupled to SAM4C MCU
  - ANSI & IEC Comprehensive Metrology FW offering



# MCP3914 ADC

## ● Особенности

- **94.5 dB SINAD, -107 dBc Total Harmonic Distortion (THD) (up to 35th Harmonic), 112 dBFS SFDR for Each Channel**
- **• Enables 0.1% Typical Active Power Measurement Error over a 10,000:1 Dynamic Range**
- **2.7V-3.6V AVDD, DVDD**
- **• Programmable Data Rate up to 125 ksps:**
  - 4 MHz Maximum Sampling Frequency
  - 16 MHz Maximum Master Clock
- **• Oversampling Ratio up to 4096**
- **• Ultra-Low Power Shutdown Mode with < 10  $\mu$ A**
- **• -122 dB Crosstalk between Channels**
- **• Low Drift 1.2V Internal Voltage Reference: 9 ppm/°C**
- **• Differential Voltage Reference Input Pins**
- **• High Gain Programmable-Gain Amplifier (PGA) on Each Channel (up to 32 V/V)**
- **• Phase Delay Compensation with 1  $\mu$ s Time Resolution**

# MCP3914

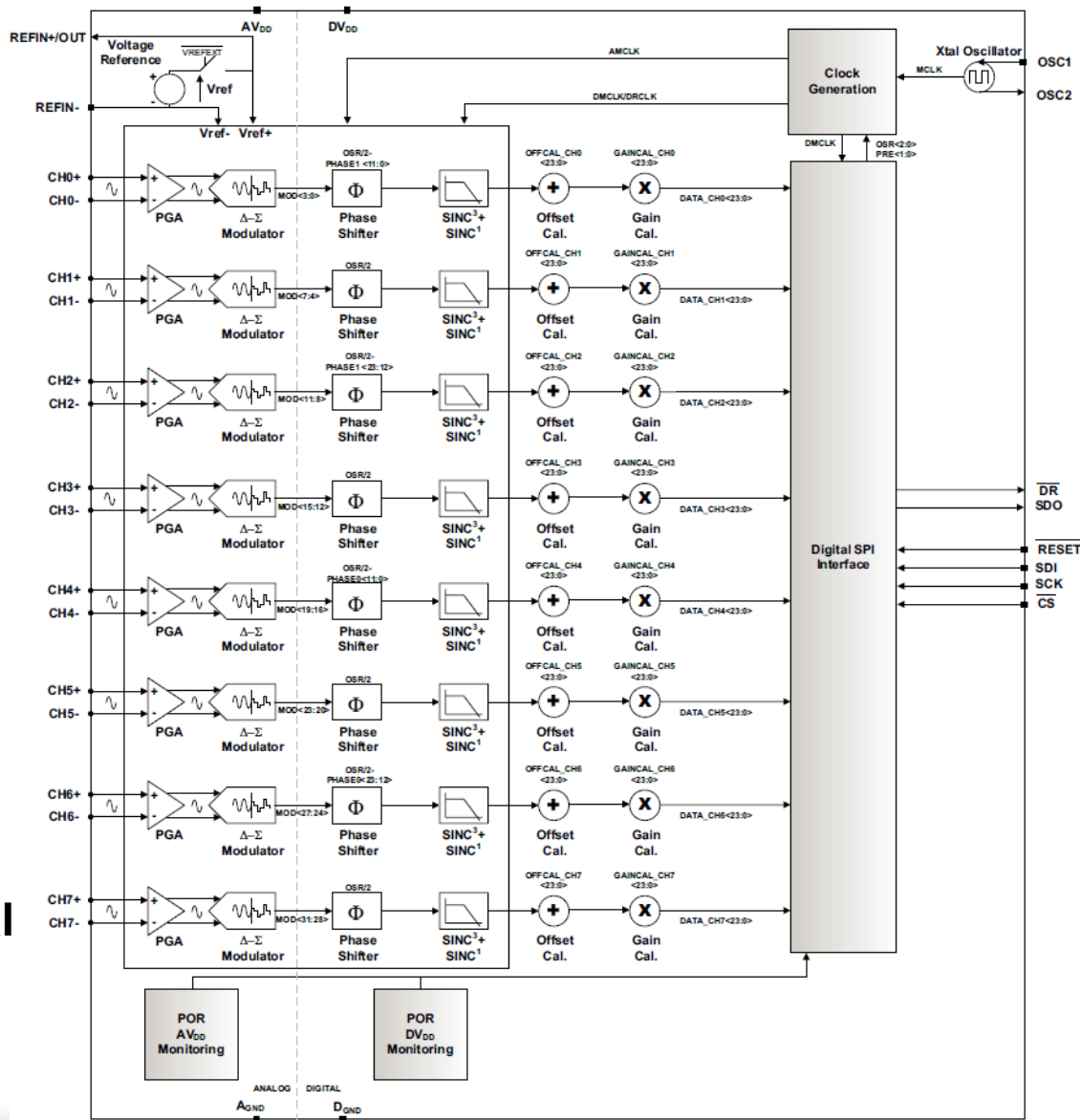

**MCP3914 internal structure**

# Microchip/Atmel 1-Φ

## ИЗМЕРИТЕЛИ

Part Number	MCP3905A/06/09 (Recommended ATM90E26 for New Design)	MCP39F5xx	ATM90E26
Number of $\Sigma\Delta$ ADC Channel	2	2 or 3	3
Accuracy	0.1%	0.1% (0.5% for 3 channels, reactive (?))	0.1% Active, 0.2% Reactive
Dynamic Range	500-1000:1	4000:1	5000:1
Calculations	Active Power Only	Power & Energy PF, f, Zero-Cross	Power & Energy PF, f, Zero-Cross
Output Pulse	Yes	No	Yes
PWM Output	No	Yes	No
Programmable Voltage Sag Detection	NA	No	Yes
Anti-tampering (N line)	No	No	Yes
Voltage Reference	15 ppm/°C	10 ppm/°C	15 ppm/°C
Internal Oscillator	No	Yes	No
CRC	No	Yes	No
Comm. I/F	No	UART, 2 Wire Mode	UART, SPI
User EEPROM	No	512B	No
Temperature Range	-40 to +125°C	-40 to +125°C	-40 to +85°C
Programmable/Flexible Event	No	Yes	No
50/60 Hz Operation	Yes	Yes	No, only 50 Hz meets regulations
Package	SSOP24	QFN20	TSSOP28
Implementation Cost	\$\$	\$\$\$	\$

# Microchip/Atmel 1-Ф измерители









- **МСР39F5хх – для промышленных задач**
  - Larger Temp Range covering Up to +125°C
  - Offer additional features (EEPROM, Flexible Events, PWM output) potentially useful in Industrial Areas
  
- **АТМ90Ех – для счетчиков**
  - Very optimized cost structure for sensitive price market
  - Support of valuable metering features requirement (N Line for Anti tampering support, ≠ Services type support, tec...)
  - Single & Poly-Phase Market Support

# Microchip/Atmel 3-Ф измерители и AFE

- **От Atmel**
  - ATM90E32AS
  - ATM90E36

# Итого по АЦП

 Good Market Fit

Тип	Серия	Счетчики	Промышлен. задачи	Особенности
AFE	MCP391x			<ul style="list-style-type: none"> <li>- Extended Temp. Range Support (Up to +125°C)</li> <li>- Up to 8x ADC channels</li> </ul>
	ATsense			<ul style="list-style-type: none"> <li>- Come along with a comprehensive Metrology FW compliant offering with ANSI &amp; IEC standards</li> <li>- Tightly coupled to ATSAM4Cx MCU series</li> </ul>
Измеритель	MCP39F5xx			<ul style="list-style-type: none"> <li>- Extended Temp. Range Support (Up to +125°C)</li> <li>- Include General Purpose Features such as Programmable Events, Embedded Eeprom, PWM</li> </ul>
	ATM90Exx			<ul style="list-style-type: none"> <li>- Ideal for Cost Sensitive Market</li> <li>- Wide Sales and Field Proven in Metering Space</li> <li>- Support of Single &amp; Poly Phase Market</li> </ul>

# MASTERS 2016

The Premier Technical Training Conference for Embedded Control Engineers



## Решения для PLC связи

## Atmel PLC





# Решения для PLC

	PL230A	PL250A	PL360A	SAM4CP16B	SAM4CP16C
Standard	PRIME	G3	Multi-protocol	PRIME	G3
Band	< 500 kHz	< 500 kHz	< 500 kHz	< 500 kHz	< 500 kHz
Core	-	-	(Cortex M7)	Dual Cortex-M4	Dual Cortex-M4
CPU Clock	-	-	216 MHz	120 MHz @core	120 MHz @core
Flash	-	-	-	1 MB	1 MB
SRAM	-	-	96/128 KB for code, 96/64 KB for data	128+16+8 KB	128+16+8 KB
Package	LQFP80	LQFP80	QFN 44 / TQFP 48	LQFP176	LQFP176
Pin to Pin	YES		NO	YES	
Availability	In production	In production	Samples: 2Q16 MP: 2Q17	In production	In production

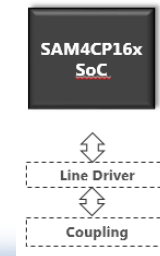
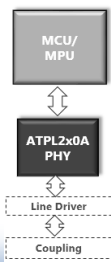



# ОСНОВНЫЕ ОСОБЕННОСТИ

- **Flexible, cost efficient solution for Smart Metering platforms:**
  - **Highly integrated SOC” option: Dual Cortex-M4 with 1MB Flash and 128kB SRAM, with Embedded cryptographic peripheral**
  - **“Two chip architecture” option: PLC transceiver plus external Atmel MCU/MPU**
- **Best-in-class PLC modem features:**
  - **Implements hardware accelerators: AES-128, FFT, Viterbi, Reed Solomon, PL Header detection.**
  - **Modem includes PLC Analog Front End (PLC AFE), only the Line Driver (power amplifier for PLC) is external.**
  - **Optimized Class D Line Driver for PLC addressing < 490 kHz band:**
    - **Comprised of few discrete components: low size & reduced BOM**
    - **Class D amplification provides highest signal injection efficiency (Tx)**
    - **Low power consumption (Rx), smaller power supply**
    - **Robust and reliable thermal behaviour**
    - **Complies with existing regulations (conducted/radiated disturbance limits, frequency bands, etc.)**

# PLC модули

## Примеры и референсы

- **ATPL2x0CH**

- Combines an ARM Cortex M4 (SAMG55J19) with a PLC AFE (PL230A/PRIME, PL250A/G3)
- OFDM-based PLC: different configurations in terms of baud rate [4.5 .. 166] kbps, robustness, tx/rx channel [36 .. 490] kHz...
- SAMG55 host (120 MHz, 512 kB Flash, 128 kB RAM) can implement PLC comms stack and control application. UART available to communicate with external MCU if required.



Top view

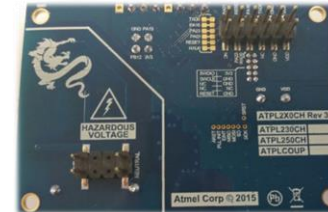

Bottom view

- **ATPL803303**

- Based on SAM4CP16B PRIME SOC, same board can be adapted to support G3-PLC (pin-to-pin compatible devices).
- Complete design available (BOM, Schematics, PCB).
- 4 layer PCB, isolated (isolation transformer and decoupling capacitor on board); single-phase coupling.

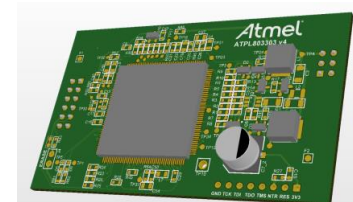

Top view

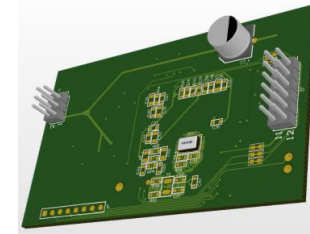

Bottom view

# ПО для PLC PRIME и G3-PLC

Users can decide to use the complete communications stack (PRIME, G3) in case of complex networks...

... or can implement their own application directly accessing the physical (PHY) layer of Atmel analog front ends for PLC (ATPL230A, ATPL250A), in case of simple networks or basic communication requirements.

SAMG55 + PL250A

SAMG55 + PL230A

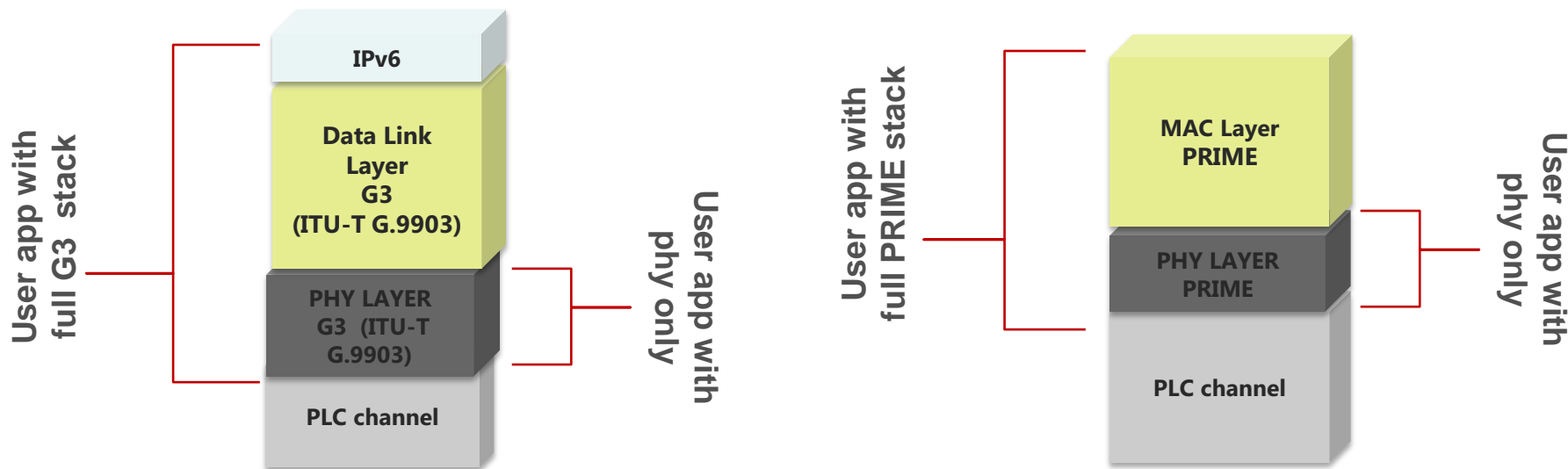

Atmel provides software and project examples for both cases with no additional charge or fee.

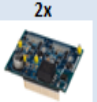
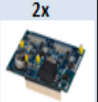

# Отладочные средства для PLC

		Part Number	Part Numbers	Status	Kit contents Pictures			IDE	RTOS	STACKS/LIBRARIES
PLC	PRIME Modem	ATPL230A-AKU-Y	ATPL230-EK (2 Modem Boards + 2 Couplings)	Available	2x 	2x 	2x 	ATMEL Studio & ASF IAR	FreeRTOS	PRIME
	PRIME SoC	ATSAM4CP16B-AHU-Y	ATSAM4CP16B-EK (2 Boards + 4 Couplings)	Available	2x 	2x 	2x 	ATMEL Studio & ASF IAR	FreeRTOS	PRIME
PLC	G3 Modem	ATPL250A-AKU-Y	ATPL250-EK (2 Modem Boards + 4 Couplings)	Available	2x 	2x 	2x 	ATMEL Studio & ASF IAR	FreeRTOS	G3
	G3 SoC	ATSAM4CP16C-AHU-Y	ATSAM4CP16C-EK (2 Boards + 4 Couplings)	Available	2x 	2x 	2x 	ATMEL Studio & ASF IAR	FreeRTOS	G3

- Atmel PLC PC tools
- PHY Tester & Tx console (PRIME, G3)
- Multi-protocol sniffer (PRIME, G3)
  - Network Manager
  - Vendor Tool
- Atmel PLC software
- ASF\_PLC: SW drivers/libraries
  - PHY IDE:
    - PHY Tester Tool Example
    - PHY Sniffer Tool Example
  - “Node” projects (IAR & AS)
  - PRIME Base Node tool (IAR & AS)
  - SW for Cycles Test (DLMS cycling emulation)

# ATPL230A - EK

## PRIME modem Evaluation Kit

### ATPL230A EK contents

- Two ATPL230AMB modem boards.
  - **2 x ATPLCOUP001, PRIME “CENELEC-A”**
  - **2 x ATPLCOUP0006, PRIME “FCC”**
- Two USB to micro-B USB cables.
- Two power cord cables (IEC320-C8), set of jumpers to configure the board (230/100 VAC, ERASE, etc)
- Schematics, PCB layout, Gerbers, BOMs...
- ATPL230A datasheet
- ANs for layout recommendations & critical design guidelines
- Software and Tools:
  - **Examples showing how to use and configure the PRIME PHY layer on the ATPL230A.**
  - **Complete PRIME SW stack to implement a PRIME Service Node, including a user application project.**
  - **Software documentation**
  - **Tools: PC applications that can be immediately used to evaluate ATPL230A and its performance (PHY tester, Sniffer, PRIME Manager Tool)**



# SAM4CP16B – EK

## PRIME SOC Evaluation Kit

### SAM4CP16B EK contents

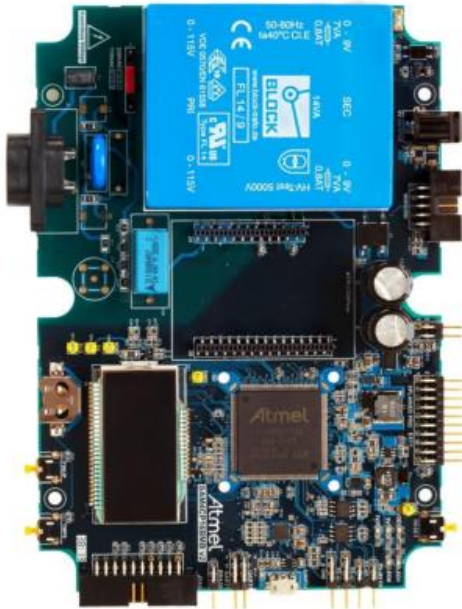

- Two SAM4CP16BMB boards
- Four PLC coupling boards:
  - **2 x ATPLCOUP001, PRIME “CENELEC-A”**
  - **2 x ATPLCOUP0006, PRIME “FCC”**
- Schematics, PCB layout, Gerbers, BOMs...
- SAM4CP16B datasheet
- AN for layout recommendations & critical design guidelines
- Software:
  - **ASF\_PLC: SW drivers/libraries for SAM4CP16B. Prepared for easy integration into any RTOS – specially FreeRTOS.**
  - **PHY IDE:**
    - PHY Tester Tool Example
    - PHY Sniffer Tool Example
- PRIME Service Node projects (IAR & AS)
- PRIME Base Node “lite” tool
- SW for Cycles Test (DLMS cycling emulation)
- SW documentation folder
- Tools: PLC PHY tester tool, PRIME Manager tool, Multiprotocol sniffer.



# ATPL250A - EK

## G3 modem Evaluation Kit

### ATPL250A EK contents

- Two ATPL250AMB modem boards.
  - **2x ATPLCOUP007 coupling boards suited for transmission and reception in the CENELEC-A frequency band.**
  - **2 x ATPLCOUP0006, G3 “FCC”**
- Two USB to micro-B USB cables.
- Two power cord cables (IEC320-C8), set of jumpers to configure the board (230/100 VAC, ERASE, etc)
- Schematics, PCB layout, Gerbers, BOMs...
- ATPL250A datasheet
- ANs for layout recommendations & critical design guidelines
- Software and Tools:
  - **Examples showing how to use and configure the G3 PHY layer on the ATPL250A.**
  - **G3 SW stack to implement a G3 device.**
  - **PAN Coordinator “lite” example application**
  - **Software documentation**
  - **Tools: PC applications that can be immediately used to evaluate ATPL250A and its performance (PHY tester, Sniffer)**





# SAM4CP16C – EK

## G3 SOC Evaluation Kit

### SAM4CP16C EK contents

- Two SAM4CP16CMB modem boards.
  - 2x ATPLCOUP007 coupling boards suited for transmission and reception in the CENELEC-A frequency band.
  - 2 x ATPLCOUP0006, G3 “FCC”
- Two USB to micro-B USB cables.
- Two power cord cables (IEC320-C8), set of jumpers to configure the board (230/100 VAC, ERASE, etc)
- Schematics, PCB layout, Gerbers, BOMs...
- SAM4CP16C datasheet
- ANs for layout recommendations & critical design guidelines
- Software and Tools:
  - Examples showing how to use and configure the G3 PHY layer on the SAM4CP16C.
  - G3 SW stack to implement a G3 device.
  - PAN Coordinator “lite” example application
  - Software documentation
  - Tools: PC applications that can be immediately used to evaluate SAM4CP16C and its performance (PHY tester, Sniffer)

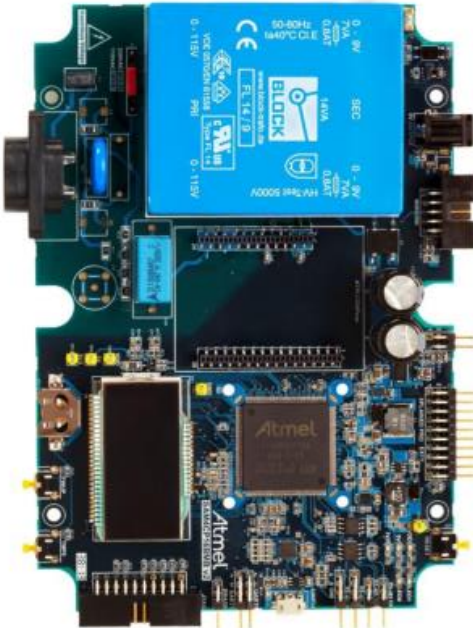

# BASENODE – EK PRIME Evaluation Kit

## BASENODE EK contents

- One ATPL230ABN board: implements SAME70 ARM Cortex M7 microcontroller, plus ATPL230A PLC device.
- Three PLC coupler boards:
  - 1 x ATPLCOUP001, PRIME “CENELEC-A”
  - 1 x ATPLCOUP002, PRIME “ARIB”
  - 1 x ATPLCOUP006, PRIME “FCC”
- Schematics, PCB layout, Gerbers, BOMs...
- AN for layout recommendations & critical design guidelines
- Software:
  - Project examples providing access and control over the PRIME PHY layer
  - Project example for a full-featured PRIME Base Node, including example user applications.
- Tools:
  - PLC PHY tester tool
  - PRIME Manager tool
  - Multiprotocol sniffer.

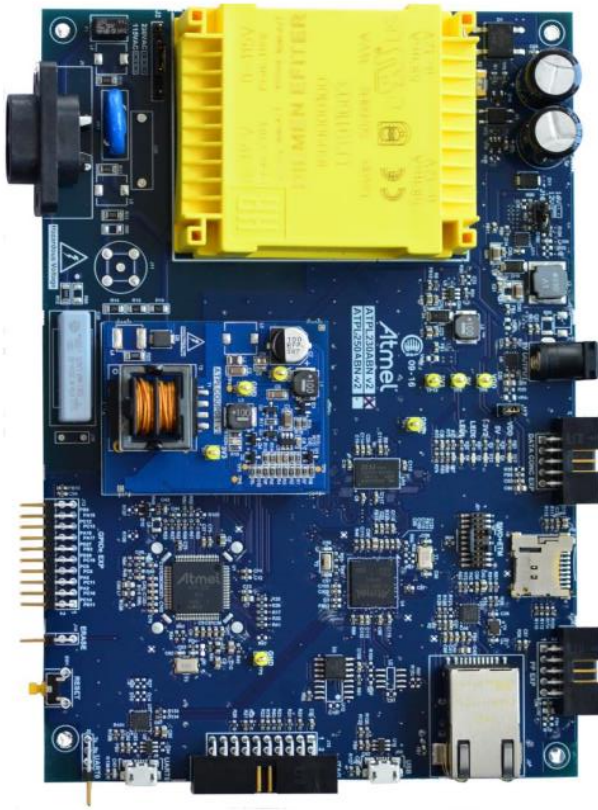

# PANCOORDINATOR– EK

## G3 Evaluation Kit

### PANCOORDINATOR EK contents



- One ATPL250ABN board: implements SAME70 ARM Cortex M7 microcontroller, plus ATPL250A PLC device.
- Three PLC coupler boards:
  - 1 x ATPLCOUP007, PRIME “CENELEC-A”
  - 1 x ATPLCOUP002, PRIME “ARIB”
  - 1 x ATPLCOUP006, PRIME “FCC”
- Schematics, PCB layout, Gerbers, BOMs...
- AN for layout recommendations & critical design guidelines
- Software:
  - Project examples providing access and control over the G3 PHY layer
  - Project example for a full-featured G3 stack for PAN Coordinator, including example user applications.
- Tools:
  - PLC PHY tester tool
  - Multiprotocol sniffer.